

Article number: 439500070
 Description: Rota-fix shaft-hub connection F70x110
 Steel
 Note: Self centering. Very high torque

Measures

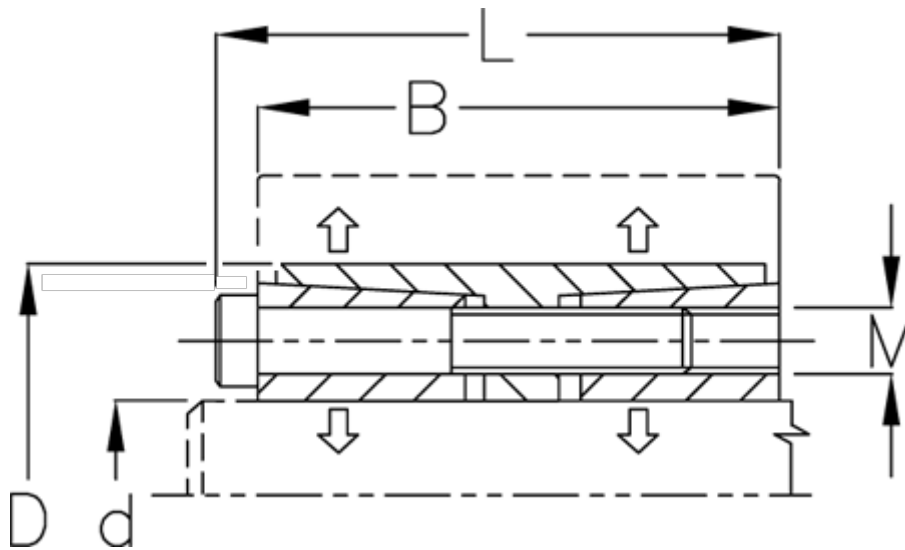

B mm	= 76
d H8 mm	= 70
D mm	= 110
Fit tolerance	= Aksel h8, Nav H8
F kN torque	= 280.0
L mm	= 86
M mm	= M10
P N/mm ² surface pressure on shaft/hub	= 100

Surface roughness	= R? ? 3.2 µm
T N m torque	= 10300
Ts N m bolt tightening torque	= 83.0